

GRW150I/S5

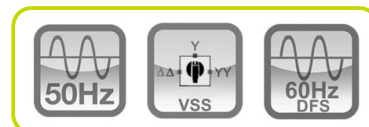

Power Rating

Emergency Standby Power ESP	kVA	165.0
Emergency Standby Power ESP	kW	132.0
Prime power PRP	kVA	150.0
Prime power PRP	kW	120.0
Frequency	Hz	50
Voltage	V	400/230
Phases	№	3
Power factor	cos φ	0.8
Fuel		Diesel
[50Hz] Exhaust emission level		Stage V
VERSION SWITCHABLE [50/60Hz]		YES



Ratings definition (ISO-8528-1)

ESP - Emergency Standby Power:

It is the maximum power available during a variable electrical power sequence, under the stated operating conditions, for which a generating set is capable of delivering in the event of a utility power outage or under test conditions for up to 200 h of operation per year with the maintenance intervals and procedures being carried out as prescribed by the manufacturers. The permissible average power output over 24 h of operation shall not exceed 70 % of the ESP.

PRP - Prime Power:

It is defined as being the maximum power which a generating set is capable of delivering continuously whilst supplying a variable electrical load when operated for an unlimited number of hours per year under the agreed operating conditions with the maintenance intervals and procedures being carried out as prescribed by the manufacturer. The permissible average power output over 24 h of operation shall not exceed 70 % of the prime power.

G2 class load acceptance in accordance with ISO 8528-5: Higher performance classes check upon request.

Gensets are compliant with EC mark which includes the following directives and standards and subsequent modification and integration:

- 2006/42/CE Machinery safety
- 2014/30/UE Electromagnetic compatibility
- 2014/35/UE electrical equipment designed for use within certain voltage limits
- 2000/14/EC Sound Power level. Noise emissions outdoor equipment. (amended by 2005/88/EC) – If applicable
- 97/68/EC Emissions of gaseous and particulate pollutants. (amended by 2016/1628 EC) – If applicable
- ISO 8528 as applicable
- 2011/65 ROHS
- EN 12100, EN 13857, EN 60204 as referred into the ISO8528-13

Company with quality certification ISO 9001

Power supply 60Hz 480V Three Phase (with supplement DFS)

Frequency	Hz	60
Voltage	V	480/277
Phases	№	3
Power factor	$\cos \phi$	0.8
Emergency Standby Power ESP	kVA	194.2
Emergency Standby Power ESP	kW	155.4
Prime power PRP	kVA	175.5
Prime power PRP	kW	140.4
Max current	A	234
Nominal current	A	211



Engine specifications

Engine Brand		FPT
Model		NEF67TEVP06
Engine cooling system		Water
Nr. of cylinder and disposition		6 in line
Displacement	cm ³	6700
Aspiration		Turbocharged aftercooled
Speed governor		Electronic
Oil capacity	l	18
Lube oil consumption PRP (max)	%	0.3
Coolant capacity	l	28
Electric circuit	V	24
Fuel		Diesel
DEF consumption (as % of Fuel consumption)	%	10.2
VERSION SWITCHABLE [50/60Hz]		YES
ENGINE DATA	Hz	50
[50Hz] Operating Speed-Nominal	rpm	1500
[50Hz] Exhaust emission level		Stage V
[50Hz] Specific fuel consumption 75% PRP	g/kWh	194
[50Hz] Specific fuel consumption 100% PRP	g/kWh	194
ENGINE DATA	Hz	60
[60Hz] Operating Speed-Nominal	rpm	1800
[60Hz] Specific fuel consumption 75% PRP	g/kWh	198
[60Hz] Specific fuel consumption 100% PRP	g/kWh	196

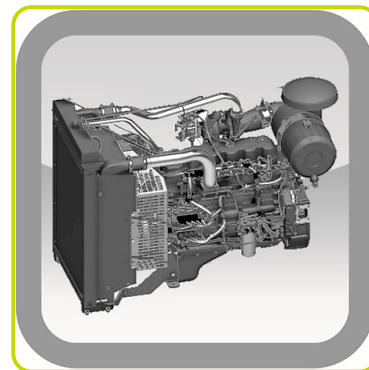

Alternator Specifications

Alternator		Leroy Somer
Model		LSA 44.3 L10
Type		Brushless
Class		H
IP protection		23
Insulation Protection Systems		Protection System 2
Poles		4
Winding leads		12
Voltage regulation system		Electronic
Voltage tolerance	%	1



Installation data

[50Hz] Cooling air	m ³ /min	252.70
[50Hz] Exhaust gas flow PRP	m ³ /min	26.3
[50Hz] Exhaust gas temperature ESP	°C	550
[60Hz] Cooling air	m ³ /min	318.20
[60Hz] Exhaust gas flow PRP	m ³ /min	32.9
[60Hz] Exhaust gas temperature ESP	°C	560

Electrical Data

Battery Voltage	V	24
Circuit breaker	A	250
Max current	A	238



Genset Equipment

CANOPY

Canopy painted made up of modular panels with 1000h+ tested salt spray resistant zined metal sheet, with access doors on each side with high quality gaskets and lockable handles for easy maintenance and service.

BASE FRAME

Heavy duty base guarantees the highest standards of durability and resistance, painted using a high quality powder coating process (1000+h tested salt spray resistance).

Fully bunded, able to retain 110% of all the sets fluids, the base frame is provided with integrated fork pockets and pull bar for easy maneuverability and site positioning.

SINGLE LIFTING POINT

Access easy by rung and handle incorporated (available on both sides).

MANUAL BATTERY SWITCH

EARTH ROD

Earth stock with cable fixed inside the genset.

DOCS HOLDER

Box intenal for documents, manuals and electrical drawings.

HOT PARTS PROTECTIONS

LUBE OIL DRAIN PUMP

Makes it easier to the engine oil change.

FUEL VALVE (6 WAY)

System designed for use the fuel from external tank and increase the autonomy of the generator.

FUEL TANK

Integrated metal fuel tank complete with double fuel refiling point (one each side).

LEAK PROOF TRAY WITH DETECTOR SENSOR

Fluid leak check in the leak proof tray.

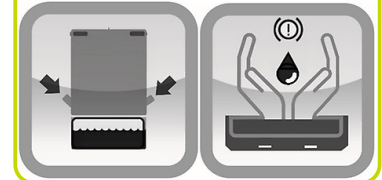
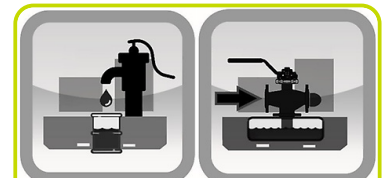
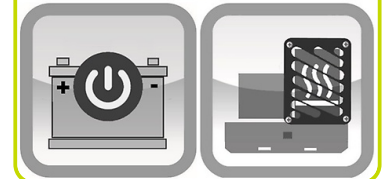
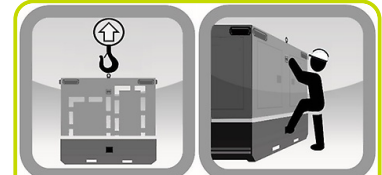
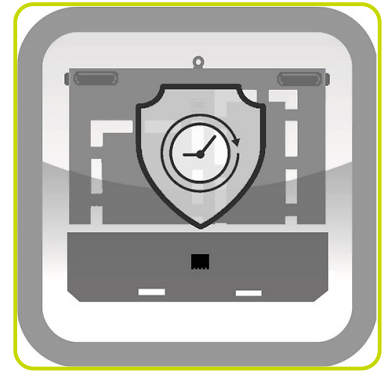

Fuel Tank - Autonomy

Fuel tank location		Internal
Fuel tank material		Metal
Fuel tank capacity	l	310
[50Hz 400V] Fuel consumption 75% PRP	l/h	23.39
[50Hz 400V] Running time 75% PRP	h	13.25
[50Hz 400V] Fuel consumption 100% PRP	l/h	30.92
[50Hz 400V] Running time 100% PRP	h	10.03
[60Hz 480V] Fuel consumption 75% PRP	l/h	28.55
[60Hz 480V] Running time 75% PRP	h	10.86
[60Hz 480V] Fuel consumption 100% PRP	l/h	37.10
[60Hz 480V] Running time 100% PRP	h	8.36

DEF tank

DEF tank Capacity	l	43
DEF consumption (as % of Fuel consumption)	%	10.2
[50Hz 400V] DEF Autonomy 75% PRP	h	18.02
[60Hz 480V] DEF Autonomy 75% PRP	h	14.77



Control panel - Options Available:

AUTOMATIC CONTROL PANEL	ACP
MODULAR PARALLEL PANEL	MPP



ACP - AUTOMATIC CONTROL PANEL

CONTROL SECTION:

- Auto Mains Failure (AMF) function
- Gen-set controller for single genset operating in standby or prime power modes
- Full gen-set monitoring and protection
- Detailed event and performance log with time and date
- Emergency push button
- Extra Instrumentation (analogue): Fuel level meter; Mechanical hour counter
- Differential protection with internal switch
- Battery charger.

SOCKET SECTION:

- Two wires facility for remote start/stop
- Plug for auxiliary power supply
- Socket Kit: Equipment and configurations available as a supplement.

POWER SECTION:

- It integrates 4 poles modular circuit breaker suitably rated with thermal and magnetic overloads.
- Large and robust busbar with cables passage opening from the bottom for easy power cable connection.
- Provided with safety switch to trip circuit breaker if operator open the power section door to operate on the bus bar.

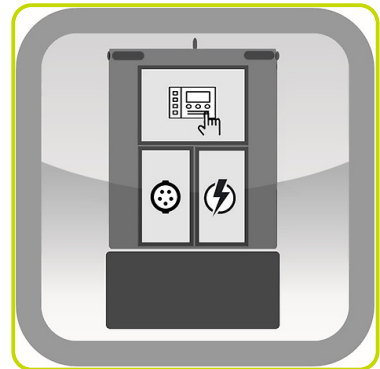

MPP - MODULAR PARALLEL PANEL

CONTROL SECTION:

- Modular parallel panel allows the genset to work in parallel (up to 32 gen-sets)
- Easy switching between parallel to mains or multiple genset applications
- Full gen-set monitoring and protection
- Detailed event and performance log with time and date
- Colour display 7" TFT with 800x480 px resolution
- Wide range of communication and connection capabilities available
- Emergency push button
- Extra Instrumentation (analogue): Fuel level meter; Mechanical hour counter
- Differential protection with internal switch
- Battery charger.

SOCKET SECTION:

- Multi-pin connectors for parallel running.
- Two wires facility for remote start/stop.
- Plug for auxiliary power supply.
- Socket Kit: Equipment and configurations available as a supplement.

POWER SECTION

- It integrates 4 poles motorized moulded case circuit breaker suitably rated with thermal and magnetic overloads
- Large and robust busbar with cables passage opening from the bottom for easy power cable connection.
- Provided with safety switch to trip circuit breaker if operator open the power section door to operate on the bus bar.

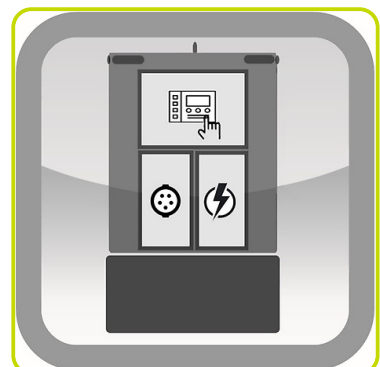

CANOPY VERSION

- Weatherproof Enclosure made of galvanized sheet metal allows to protect genset from corrosion and aggressive condition.
- Enclosure soundproofed by means of washable and fireproof soundproofing material, allow to reach low noise level.
- Exhaust residential silencer integrated inside the genset equipped with rain flap.
- Enclosure equipped with bumpers to prevent damage during genset handling and transport.

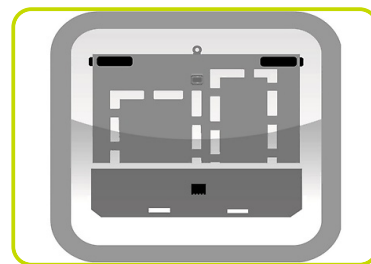

Dimensional data Canopy Version

Length	(L) mm	4200
Width	(W) mm	1200
Height	(H) mm	2050

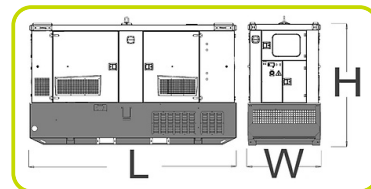

Weight	kg	2899
--------	----	------

Noise Level 50Hz

Guaranteed noise level (LWA)	dB(A)	97
Noise pressure level @ 1 m	dB(A)	78
Noise pressure level @ 7 m	dB(A)	68



OPTIONAL FEATURES:

To be ordered with equipment (when necessary) :

ELECTRICAL OPTION

Internal Canopy Lighting system with manual switch	ICL
Control section internal lighting (automatic with door switch)	CLS
DSE2157 Output (8) Expansion Module	ARM7
DSE890 MKII DSEWebNet ® Gateway 4G (GSM/Ethernet)	RGW2
Engine analogue gauges (water temp / oil pressure)	EAG
Insulation Monitoring Device (Replace standard differential protection)	IMD
Socket kit	SPK
Power lock	PWL
Bus bar arrangement	ERDF

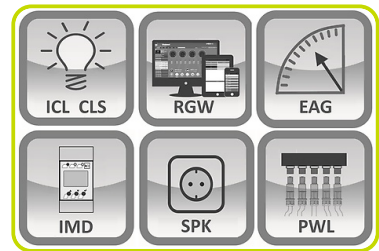

MECHANICAL OPTION

Pre-heating system	PHS
Air Inlet Preheater	APH
Heavy-Duty Air Filter	HDF
Exhaust Spark Arestor ATEX certified	ESA
Air Shut-Off Valve	ASV
Galvanized Sliding Skid	GGs
Baseframe Bumpers	BFB
Quick Fit Fuel and Urea connectors - Stage V	QFC - S5
Quick Fit Fuel and Urea connectors inside the canopy - StageV	QFC1 - S5

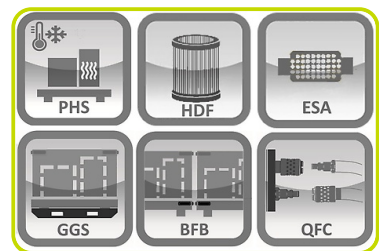

ACCESSORIES

Items available as accessory equipment	:
Site trailer	STR
Road Trailer	RTR
Road Trailer with Drawbar Height-Adjustable	RTR-B
Load Transfer Switch [Accessories for ACP Panel]	LTS

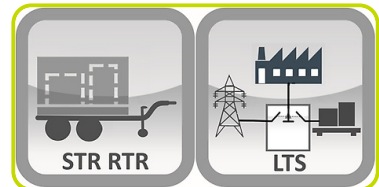

ETOP
creat să reziste

Republica Moldova, MD-2023
mun. Chişinău, str. Uzinelor 90
+ /373/ 67 707 707
office@etop.md
www.etop.md